

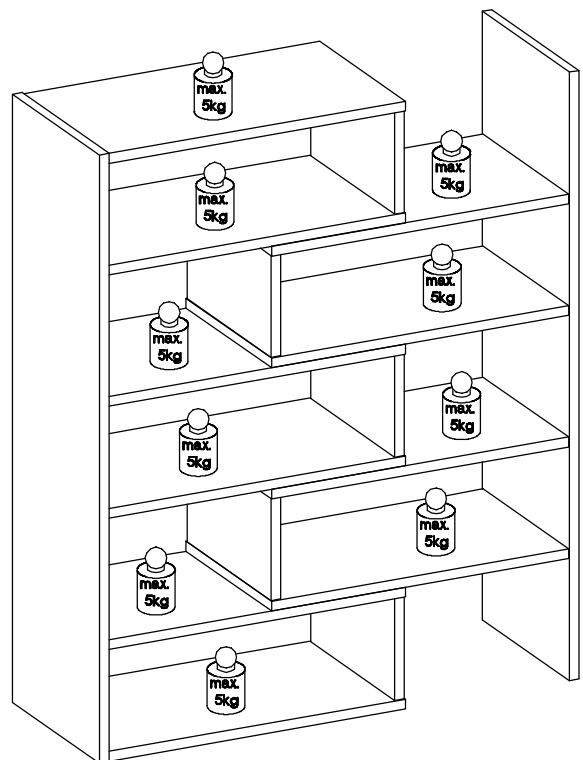

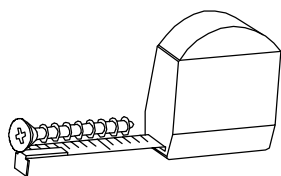

KLOE II

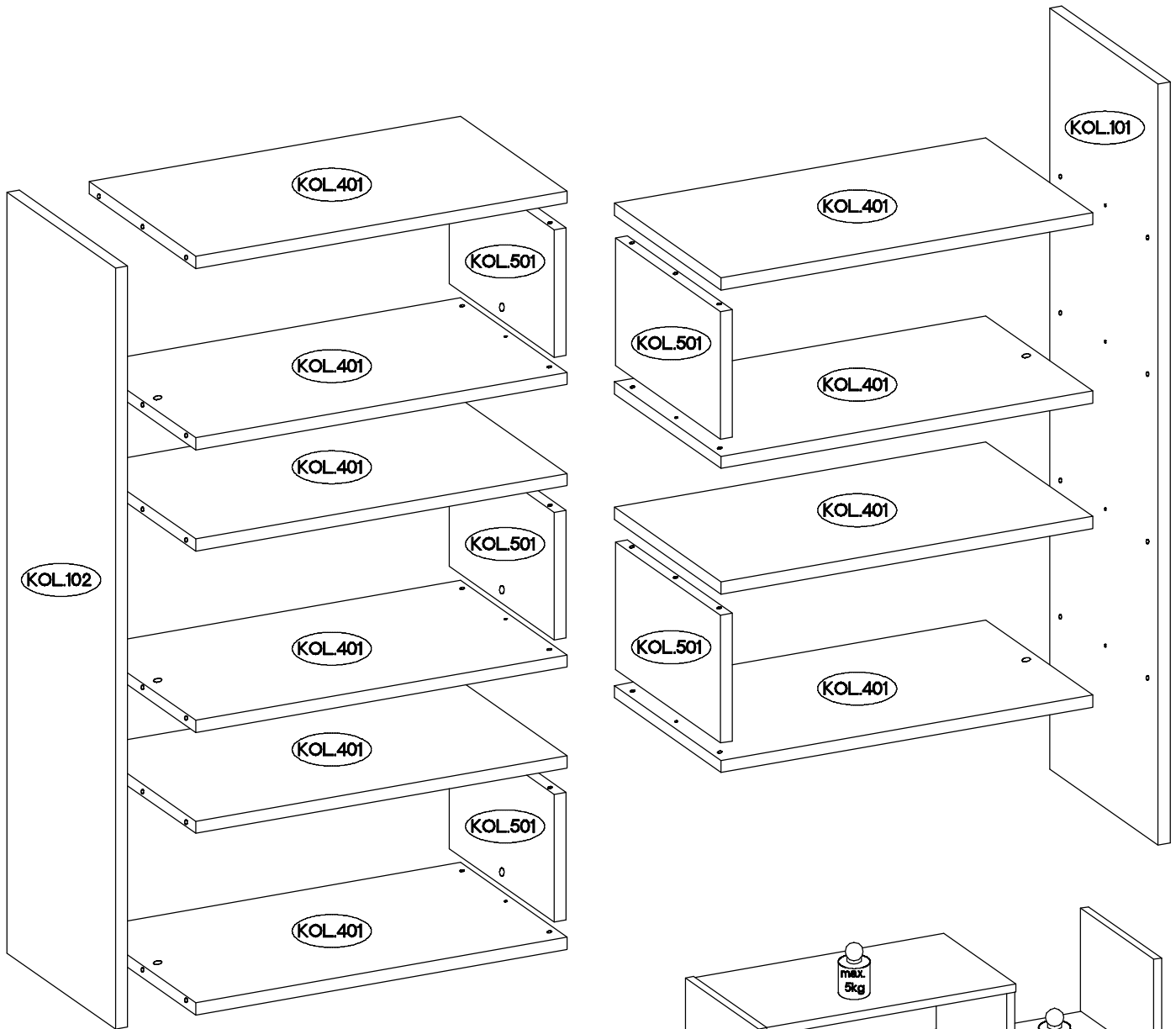
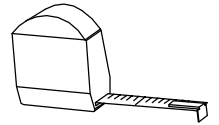
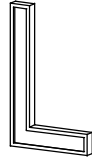
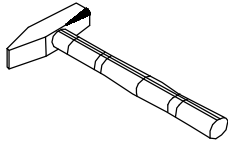
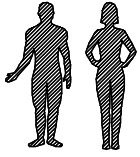

 4x30mm A 40	 L=20mm D2 20	 4x5/12mm C 20	 4x5/5mm F4 6	 E 20	 0,05 O11 1
-------------------------------------	--------------------------------------	---------------------------------------	--------------------------------------	--------------------	------------------------------------

1.

 $\pm 8 \times 30 \text{ mm}$	 L=20mm	 $\pm 15 / 12 \text{ mm}$	 0,05
A	D2	C	O11
40	20	20	1

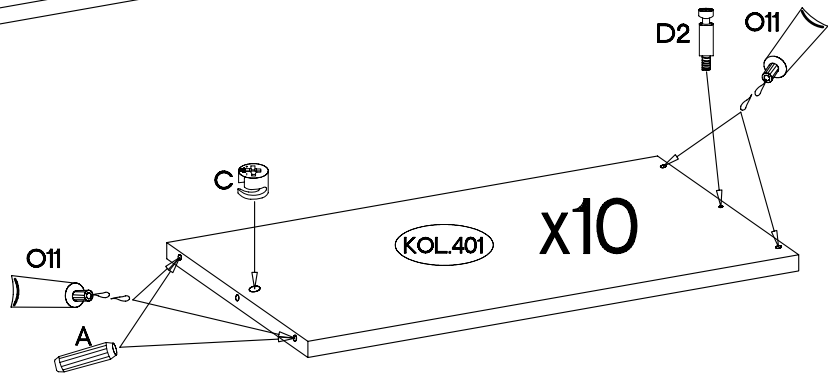
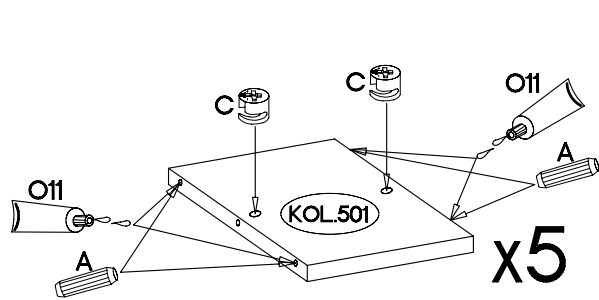
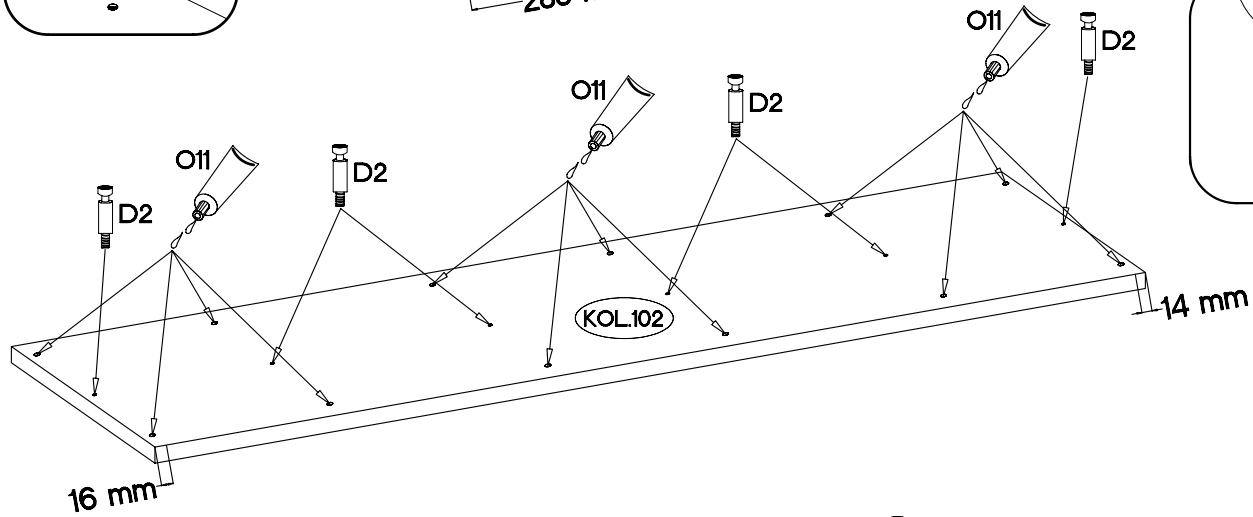
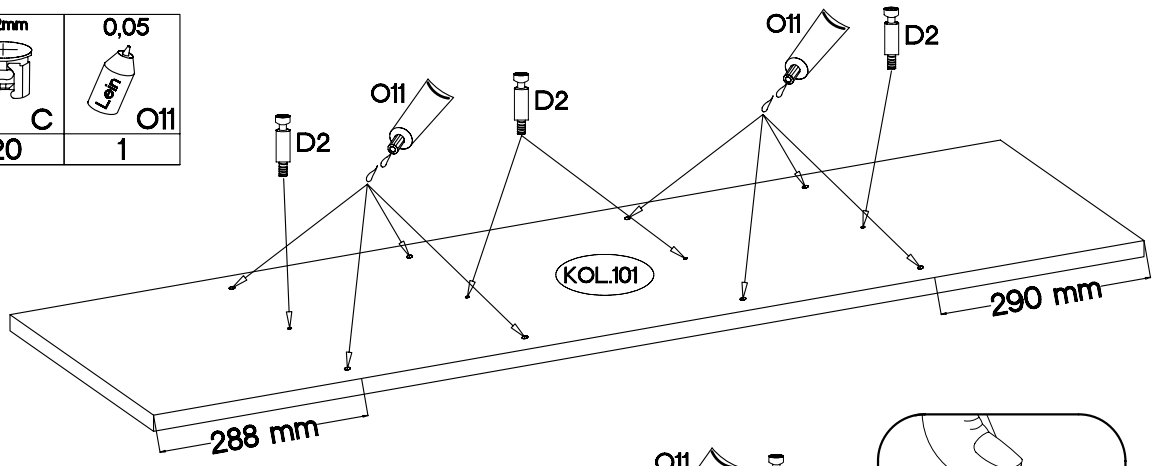
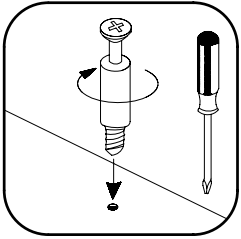

2.

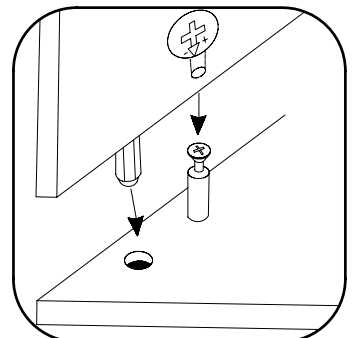
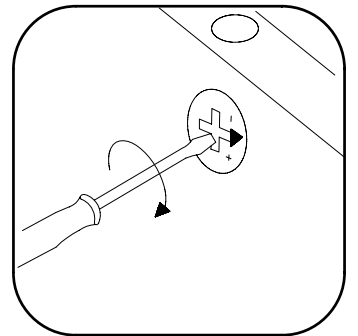
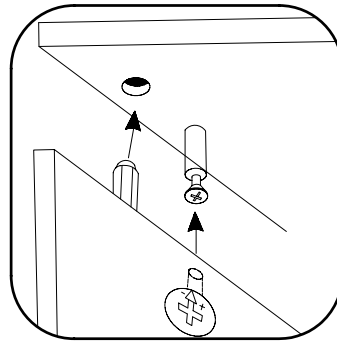
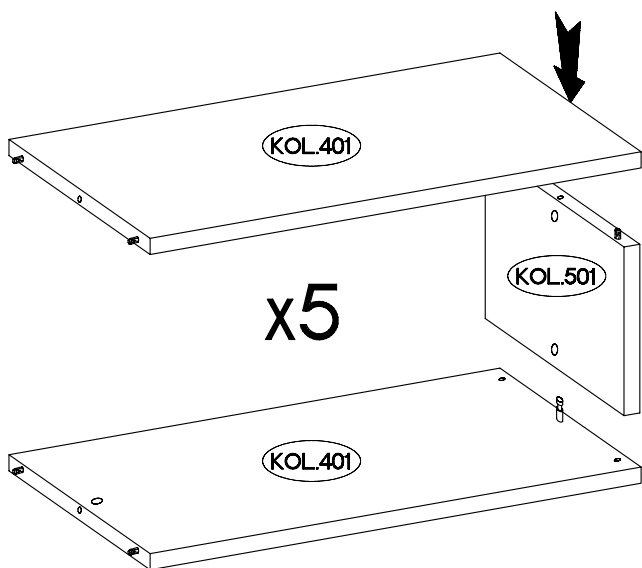

3.

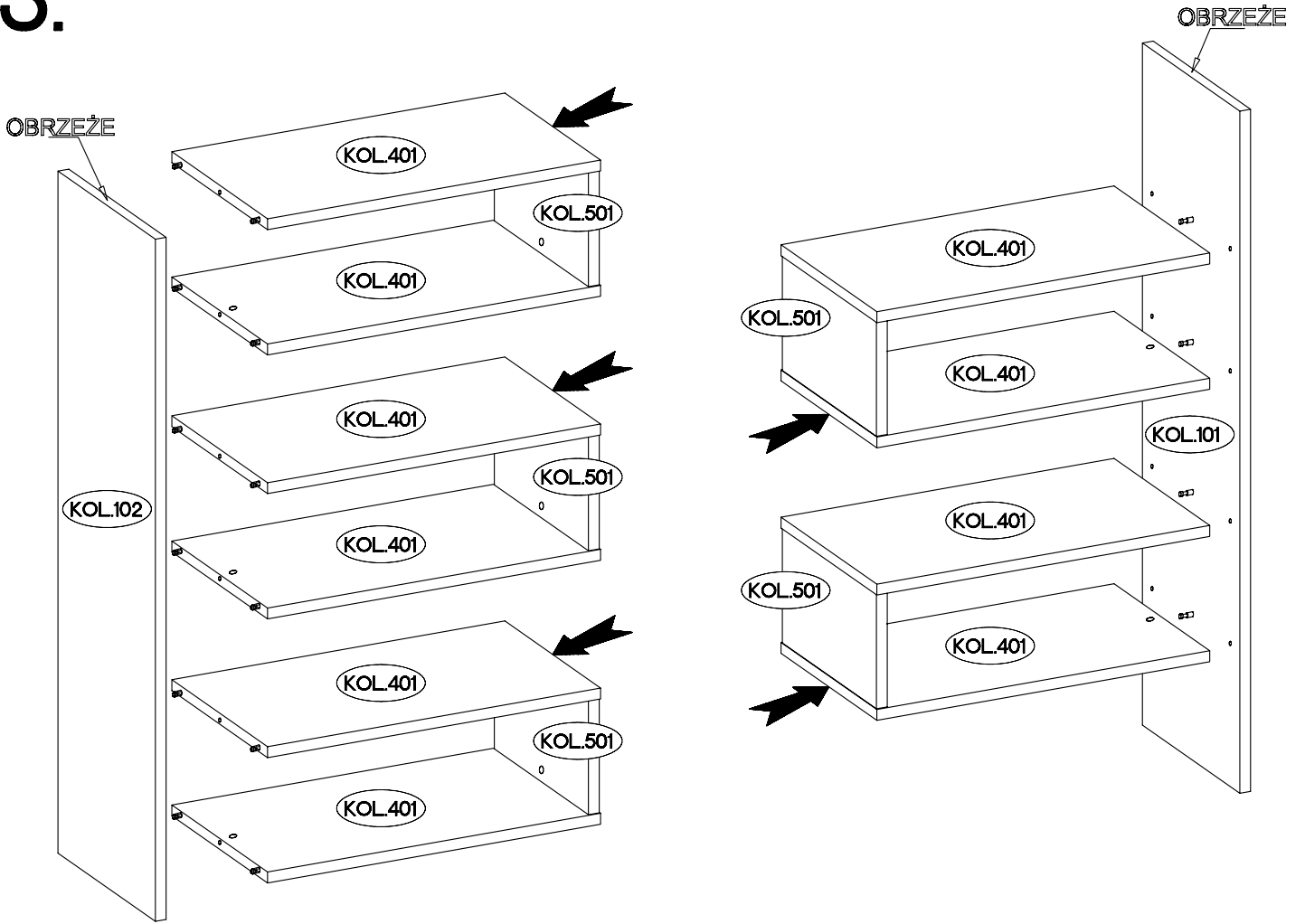

4.

Ø15x5mm	
F4	E
6	20

